

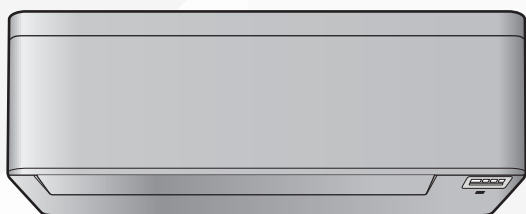

DAIKIN ROOM AIR CONDITIONER

OPERATION MANUAL



Enjoy year-round comfort.

MODELS

FTXJ25T2VMAW

FTXJ35T2VMAW

FTXJ50T2VMAW

FTXJ60T2VMAW

FTXJ25T2VMAK

FTXJ35T2VMAK

FTXJ50T2VMAK

FTXJ60T2VMAK



CONTENTS

1. Read Before Operation	1
1-1 Safety Precautions	1
2. About the system	3
2-1 Indoor unit.....	3
2-2 About the remote controller.....	3
2-2-1 Components: Remote controller.....	4
2-2-2 Status: Remote controller LCD.....	4
2-2-3 To operate the remote controller.....	4
3. Before operation.....	5
3-1 To fix the remote controller to the wall	5
3-2 To insert the batteries	5
3-3 Clock	5
3-3-1 To set the clock.....	5
3-4 Brightness of the indoor unit display	6
3-4-1 To set the brightness of the indoor unit display	6
3-5 To turn on the power supply	6
3-6 To change indoor unit position setting	6
4. Operation	6
4-1 Operation range.....	6
4-2 When to use which feature.....	7
4-3 Operation mode and temperature setpoint	7
4-3-1 To start/stop operation and to set the temperature	7
4-3-2 Airflow rate	8
4-3-3 Airflow direction.....	8
4-3-4 Comfort airflow and Intelligent eye operation.....	8
4-3-5 Powerful operation	10
4-3-6 Econo and Outdoor unit quiet operation	10
4-4 Flash streamer air cleaning operation.....	10
4-4-1 To start/stop Flash streamer operation	11
4-5 OFF/ON timer operation	11
4-5-1 To start/stop OFF timer operation.....	11
4-5-2 To start/stop ON timer operation.....	11
4-5-3 To combine OFF timer and ON timer	11
4-6 Weekly timer operation	12
4-6-1 To set Weekly timer operation.....	12
4-6-2 To copy reservations	13
4-6-3 To confirm reservations	13
4-6-4 To deactivate and reactivate Weekly timer operation	13
4-6-5 To delete reservations	13
4-7 Wireless LAN connection.....	14
4-7-1 Precautions when using the wireless adapter.....	14
4-7-2 To install the Daikin Mobile Controller application.....	14
4-7-3 To set the wireless connection.....	14
5. Energy saving and optimum operation.....	16
6. Maintenance and service	16
6-1 Overview: Maintenance and service	16
6-2 To clean the indoor unit and remote controller.....	17
6-3 To clean the front panel.....	17
6-4 To open the front panel	17
6-5 About the air filters	17
6-6 To clean the air filters	18
6-7 To clean the titanium apatite deodorising filter	18
6-8 To close the front panel	18

6-9 To remove the front panel.....	19
6-10 Take following items into account before a long idle period.....	19
7. Troubleshooting	19
7-1 Symptoms that are NOT system malfunctions	21
7-1-1 Symptom: A sound like water flowing is heard	21
7-1-2 Symptom: A blowing sound is heard.....	21
7-1-3 Symptom: A ticking sound is heard.....	21
7-1-4 Symptom: A whistling sound is heard	21
7-1-5 Symptom: A clicking sound during operation or idle time is heard.....	21
7-1-6 Symptom: A clopping sound is heard	21
7-1-7 Hissing / Cracking sound.....	21
7-1-8 A mechanical moving sound.....	21
7-1-9 Symptom: White mist comes out of a unit (Indoor unit, outdoor unit).....	21
7-1-10 Symptom: The units can give off odours.....	21
7-1-11 Symptom: The outdoor fan rotates while the air conditioner is not in operation	21
7-2 Solving problems based on error codes	21
7-3 Troubleshooting for wireless connection adapter	22
8. Disposal	22

1. Read Before Operation



1-1 Safety Precautions

	Read the precautions in this manual carefully before operating the unit.
	This appliance is filled with R32.

- Keep this manual where the user can easily find it.
- The precautions described herein are classified as WARNING and CAUTION. They both contain important information regarding safety. Be sure to observe all precautions without fail.



 **WARNING**Failure to follow these instructions properly may result in personal injury or loss of life.

 **CAUTION**Failure to follow these instructions properly may result in property damage or personal injury, which may be serious depending on the circumstances.



	Never attempt.
	Be sure to follow the instructions.
	Be sure to establish an earth connection.

- After reading, keep this manual in a convenient place so that you can refer to it whenever necessary. If the equipment is transferred to a new user, be sure also to hand over the manual.

WARNING

-  Do not use means to accelerate the defrosting process or to clean, other than those recommended by the manufacturer.
 - The appliance must be stored in a room without continuously operating ignition sources (for example: open flames, an operating gas appliance or an operating electric heater).
 - Do not pierce or burn.
 - Be aware that refrigerants may not contain an odour.
 - Floor area required for installation of the equipment, refer to the installation manual of the outdoor unit.
 - To avoid fire, explosion or injury, do not operate the unit when harmful gases (e.g. flammable or corrosive) are detected near the unit.
 - Be aware that prolonged, direct exposure to cool or warm air from the air conditioner, or to air that is too cool or too warm, can be harmful to your physical condition and health.
 - Do not place objects, including rods, your fingers, etc., in the air inlet or outlet. Product damage or personal injury may result due to contact with the air conditioner's high-speed fan blades.
 - Do not attempt to repair, dismantle, reinstall or modify the air conditioner yourself as this may result in water leakage, electric shock or fire hazards.
 - Do not use flammable spray near the air conditioner, or otherwise fire may result.
 - Do not use a refrigerant other than the one indicated on the outdoor unit (R32) when installing, moving or repairing.
Using other refrigerants may cause trouble or damage to the unit, and personal injury.
 - To avoid electric shock, do not operate with wet hands.
-
-  Beware of fire in case of refrigerant leakage. If the air conditioner is not operating correctly, i.e. not generating cool or warm air, refrigerant leakage could be the cause. Consult your dealer for assistance. The refrigerant within the air conditioner is safe and normally does not leak.
However, in the event of a leakage, contact with a naked burner, heater or cooker may result in generation of noxious gas. Do not use the air conditioner until a qualified service person confirms that the leakage has been repaired.
 - Do not attempt to install or repair the air conditioner yourself. Improper workmanship may result in water leakage, electric shock or fire hazards. Please contact your local dealer or qualified personnel for installation and maintenance work.
 - If the air conditioner is malfunctioning (giving off a burning odour, etc.), turn off power to the unit and contact your local dealer. Continued operation under such circumstances may result in a failure, electric shock or fire hazards.
 - Be sure to install an earth leakage circuit breaker. Failure to install an earth leakage circuit breaker may result in electric shock or fire.
-
-  Be sure to earth the unit. Do not earth the unit to a utility pipe, lightning conductor or telephone earth lead. Imperfect earthing may result in electric shock.

CAUTION

-  Do not use the air conditioner for purposes other than those for which it is intended. Do not use the air conditioner for cooling precision instruments, food, plants, animals or works of art as this may adversely affect the performance, quality and/or longevity of the object concerned.
 - Do not expose plants or animals directly to the airflow from the unit as this may cause adverse effects.
 - Do not place appliances that produce naked flames in places exposed to the airflow from the unit as this may impair combustion of the burner.
 - Do not block the air inlets nor outlets. Impaired airflow may result in insufficient performance or trouble.
 - Do not sit on the outdoor unit, put things on the unit, or pull the unit. Doing so may cause accidents, such as falling or toppling down, thus resulting in injury, product malfunctioning, or product damage.
 - Do not place objects that are susceptible to moisture directly beneath the indoor or outdoor units. Under certain conditions, condensation on the main unit or refrigerant pipes, air filter dirt or drain blockage may cause dripping, resulting in fouling or failure of the object concerned.
 - After prolonged use, check the unit stand and its mounts for damage. If they are left in a damaged condition, the unit may fall and cause injury.
 - To avoid injury, do not touch the air inlet or aluminium fins of the indoor or outdoor units.
 - The appliance is not intended for use by unattended young children or infirm persons. Impairment of bodily functions and harm to health may result.
 - Children should be supervised to ensure that they do not play with the unit or its remote controller. Accidental operation by a child may result in impairment of bodily functions and harm health.
 - Avoid impacts to the indoor and outdoor units, or otherwise product damage may result.
 - Do not place flammable items, such as spray cans, within 1m of the air outlet.
The spray cans may explode as a result of hot air from the indoor or outdoor units.
 - Be careful not to let pets urinate on the air conditioner. Urination on the air conditioner may result in electric shock or fire.
 - Do not wash the air conditioner with water, as this may result in electric shock or fire.
 - Do not place water containers (vases, etc.) above the unit, as this may result in electric shock or fire hazards if they should topple over.
 - Do not insert the batteries in the wrong polarity (+/-) orientation as this may result in short circuiting, fire, or battery leakage.
-
-  To avoid oxygen depletion, ensure that the room is adequately ventilated if equipment such as a burner is used together with the air conditioner.
 - Before cleaning, be sure to stop unit operation and turn off the circuit breaker. Otherwise, an electric shock and injury may result.
 - Only connect the air conditioner to the specified power supply circuit. Power supplies other than the one specified may result in electric shock, overheating and fires.
 - Arrange the drain hose to ensure smooth drainage. Imperfect drainage may cause wetting of the building, furniture, etc.

⚠ CAUTION

- Do not place objects in direct proximity of the outdoor unit and do not let leaves and other debris accumulate around the unit. Leaves are a hotbed for small animals which can enter the unit. Once inside the unit, such animals can cause malfunctions, smoke or fire if they come into contact with electrical parts.
- Do not place objects around the indoor unit. Doing so may have an adverse influence on the performance, product quality, and life of the air conditioner.
- This appliance is not intended to be used by persons with reduced physical, sensory or mental capabilities, or with lack of operation knowledge, unless they have been given supervision or instruction concerning the appliance use by person responsible for their safety. Keep out of children's reach to ensure that they do not play with the appliance.

FTPF008

Precautions relating to area surrounding the indoor and outdoor units

- Be sure to follow the instructions below.
- The indoor unit is at least 1 m away from any television or radio set (unit may cause interference with the picture or sound).
- Refrain from using the units in areas prone to high levels of oily smoke, such as a kitchen. Water leakage may result.

2. About the system

⚠ CAUTION

The indoor unit contains radio equipment. Minimum separation distance between the radiating part of the equipment and the user is 10cm.

2-1 Indoor unit

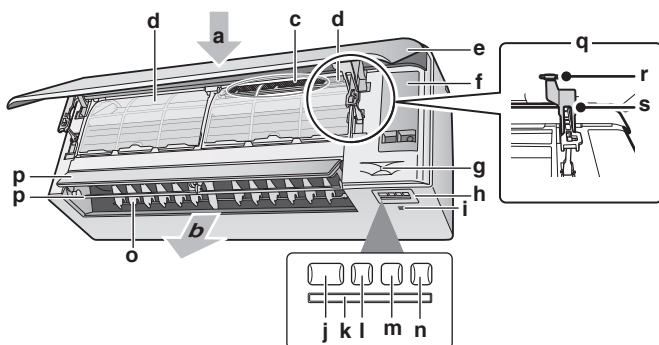

- a Air inlet
- b Air outlet
- c Titanium apatite deodorising filter
- d Air filter
- e Front panel
- f Service lid
- g Intelligent eye sensor
- h Display
- i Room temperature and humidity sensor
- j ON/OFF button and operation lamp (green)
- k Signal receiver
- l Timer lamp (orange)
- m Intelligent eye lamp (green)
- n Wireless adapter ON/OFF button

- o Louvres (vertical blades)
- p Flaps (horizontal blades)
- q Backside of the front panel
- r Fixing tab
- s Support

i INFORMATION

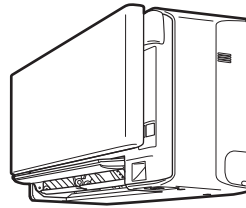

- During operation, the front panel rises to the position shown in the illustration.
- If the front panel does not rise during operation, make sure that there are no foreign objects or other things obstructing it.

⚠ CAUTION

Do not touch the front panel during operation (while it is in a raised position or as it is moving up or down). Doing so may result in injury or damage.

ON/OFF button

If the remote controller is missing, you can use the ON/OFF button on the indoor unit to start/stop operation. When operation is started using this button, the following settings are used:

- Operation mode = Automatic
- Temperature setting = 25°C
- Airflow rate = Automatic

2-2 About the remote controller

- **Direct sunlight.** Do NOT expose the remote controller to direct sunlight.
- **Dust.** Dust on the signal transmitter or receiver will reduce sensitivity. Wipe off dust with a soft cloth.
- **Fluorescent lights.** Signal communication might be disabled if fluorescent lamps are in the room. In that case, contact your installer.
- **Other appliances.** If the remote controller signals operate other appliances, move the other appliances, or contact your installer.
- **Curtains.** Make sure that the signal between the unit and the remote controller is NOT blocked by curtains or other objects.

⚠ NOTICE

- Do NOT drop the remote controller.
- Do NOT let the remote controller get wet.

2-2-1 Components: Remote controller

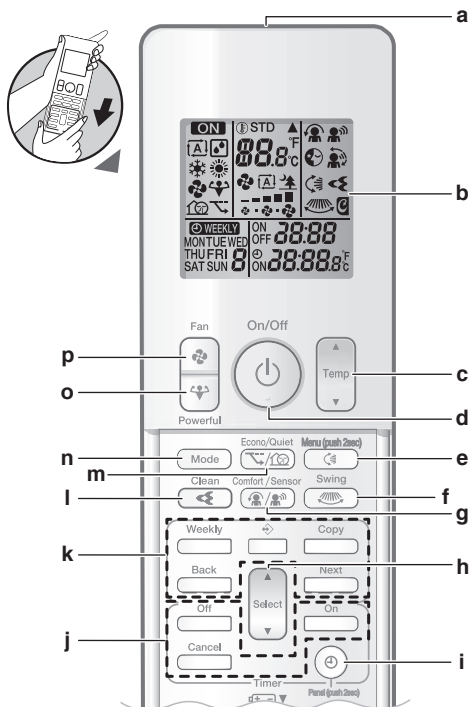

- a Signal transmitter
- b LCD display
- c Temperature adjustment button
- d ON/OFF button
- e Vertical swing button and menu (push 2 seconds)
- f Horizontal swing button
- g Comfort airflow and Intelligent eye operation button
- h Select button
- i Clock button and open panel (push 2 seconds)
- j Buttons for ON/OFF timer operation
- k Buttons for Weekly timer operation
- l Streamer
- m Econo and Outdoor unit quiet operation button
- n Mode button
- o Powerful button
- p Fan button

INFORMATION

Use (hold for 2 seconds) to open the front panel when you clean the air filters. See “6-4 To open the front panel” on page 17.

2-2-2 Status: Remote controller LCD

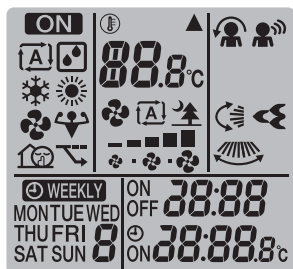

Icon	Description
	Operation is active
	Operation mode = Automatic

	Operation mode = Drying
	Operation mode = Heating
	Operation mode = Cooling
	Operation mode = Fan only
	Powerful operation is active
	Econo operation is active
	Outdoor unit quiet operation is active
	The indoor unit receives a signal from the remote controller
	Current temperature setting
	Airflow rate = Automatic
	Airflow rate = Indoor unit quiet
	Airflow rate = High
	Airflow rate = Medium high
	Airflow rate = Medium
	Airflow rate = Medium low
	Airflow rate = Low
	Comfort operation is active
	Intelligent eye is active
	Automatic vertical swing is active
	Automatic horizontal swing is active
	Streamer is active
Icon	Description
	ON timer is active
	OFF timer is active
	Weekly timer is active
	Day of the week
	Current time

2-2-3 To operate the remote controller

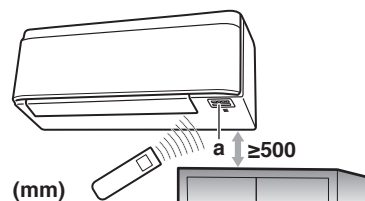

a Signal receiver

Note: Make sure that there are no obstacles within 500 mm under the signal receiver. They may influence reception performance of the remote controller.

1. Aim the signal transmitter at the signal receiver on the indoor unit (maximum distance for communication is 7 m).

Result: When the indoor unit receives a signal from the remote controller, you will hear a sound:

Sound	Description
Beep-beep	Operation starts.
Beep	Setting changes.
Long beep	Operation stops.

3. Before operation

3-1 To fix the remote controller to the wall

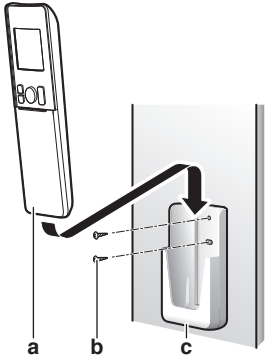

- a Remote controller (Accessory)
- b Screws (Accessory)
- c Remote controller holder (Accessory)

1. Choose a place where the signals reach the unit.
2. Attach the holder with screws to the wall or a similar location.
3. Hang the remote controller on the remote controller holder.

3-2 To insert the batteries

⚠ CAUTION

Incorrect handling of batteries can result in injury from battery leakage, rupturing or heating, or lead to equipment failure.

Please observe the following precautions and use safely.

- If the alkaline solution from the batteries should get in the eyes, do not rub the eyes. Instead, immediately flush the eyes with tap water and seek the attention of a medical professional.
- Keep batteries out of reach of children. In the event that batteries are swallowed, seek the immediate attention of a medical professional.
- Do not expose batteries to heat or fire. Do not disassemble or modify batteries. The insulation or gas release vent inside the battery may be damaged, resulting in battery leakage, rupturing, or heating.
- Do not damage or peel off labels on the batteries.

1. Slide the front cover to take it off.
2. Insert 2 dry batteries AAA.LR03 (alkaline).
3. Replace the front cover.

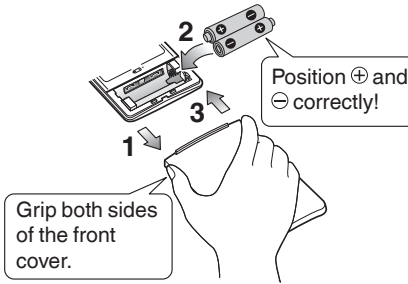

Note: To avoid possible injury or damage from battery leakage or rupturing, remove the batteries when not using the product for long periods of time.

The standard replacement time is about 1 year. Both batteries should be replaced at the same time. Be sure to replace them with new dry batteries AAA.LR03 (alkaline).

When battery power has run out, the LCD will begin blinking as an alert that the batteries need replacing. In some cases, when battery consumption is accelerated owing usage conditions, signal reception may decline before the LCD begins blinking.

The batteries supplied with the remote controller are for initial operation. The batteries may run out in less than 1 year.

3-3 Clock

If the indoor unit's internal clock is NOT set to the correct time, the ON timer, OFF timer and weekly timer will NOT operate correctly. The clock must be set again:

- After a circuit breaker has turned the unit OFF.
- After a power failure.
- After replacing batteries in the remote controller.

3-3-1 To set the clock

Note: If the time is NOT set MON, ⊕, and 0:00 blink.

1. Press ⊕.
Result: MON and ⊕ blink

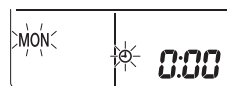

2. Press or to set the current day of the week.

Note: Holding down or increases or decreases the time setting rapidly.

Display	Day of the week
MON	Monday
TUE	Tuesday
WED	Wednesday
THU	Thursday
FRI	Friday
SAT	Saturday
SUN	Sunday

3. Press .
Result: blinks.

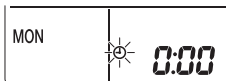

4. Press or to set the correct time.
 5. Press .

Result: Setting is complete. blinks.

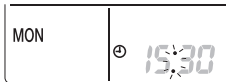

3-4 Brightness of the indoor unit display

Adjust the brightness of the indoor unit display as desired, or turn OFF the display.

3-4-1 To set the brightness of the indoor unit display

1. Press for at least 2 seconds.
Result: The menu appears on the display. is blinking.

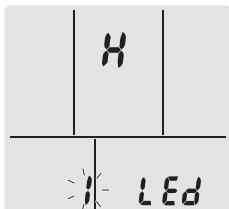

2. Press .
 3. Press or to change the setting as follows:



...is blinking	Brightness is...
	High
	Low
	Off

4. To confirm the selected setting, press .
Result: The brightness setting is changed.

Note: The display automatically returns to the default screen after 60 seconds. To return to the default screen sooner, press twice.

3-5 To turn on the power supply

1. Turn the circuit breaker on.

Result: The flap of the indoor unit will open and close to set the reference position.

3-6 To change indoor unit position setting

Set the indoor unit position to avoid direct airflow to walls.

1. Press for at least 2 seconds.
Result: The menu appears on the display.
 2. Press or to change the menu to .
Result: The menu appears on the display. blinks.

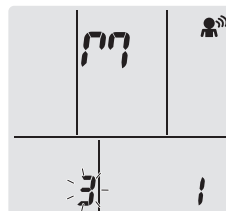

3. Press to select the menu.
Result: blinks.

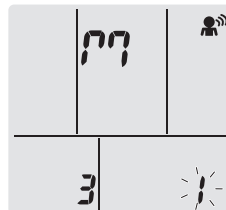

4. Press or to change the setting as follows:



If the unit is...	Symbol	Blinks	Result
In the middle of the wall (factory default setting)			
≤500 mm from the wall on right			
≤500 mm from the wall on left			

Result: The airflow range will be adjusted to avoid direct contact with the wall.

4. Operation

4-1 Operation range

Use the system in the following temperature and humidity ranges for safe and effective operation.













Operation mode	Operation range
Cooling ^{(a)(b)}	<ul style="list-style-type: none"> Outdoor temperature: -10~46°C Indoor temperature: 18~32°C Indoor humidity: ≤80%
Heating ^(a)	<ul style="list-style-type: none"> Outdoor temperature: -15~24°C Indoor temperature: 10~30°C
Drying ^(a)	<ul style="list-style-type: none"> Outdoor temperature: -10~46°C Indoor temperature: 18~32°C Indoor humidity: ≤80%

If operated outside the operation range:

- (a) A safety device might stop the operation of the system.
 (b) Condensation might occur on the indoor unit and drip.

4-2 When to use which feature

You can use the following table to determine which features to use:





Feature	Tasks
Basic features	
 Operation modes and temperature	To start/stop the system and to set the temperature: <ul style="list-style-type: none"> In Heating and Cooling mode, heat up or cool down a room. In Fan only mode, blow air in a room without heating or cooling. In Drying mode, decrease the humidity in a room. In Automatic mode, an appropriate temperature and operation mode is automatically selected.
 +  Airflow direction	To adjust the airflow direction (swing or fixed position).
 Airflow rate	To adjust the amount of air blown into the room. To run more quietly.
Advanced features	
 Streamer	To remove airborne allergens such as mold, pollen, adjuvant substances, viruses, bacteria...
 Econo	To use the system when you are also using other power-consuming appliances. To save energy.
 Outdoor unit quiet	To decrease the noise level of the outdoor unit. Example: At night.
 Comfort	To automatically adjust the airflow direction to cool down or heat up the room more effectively.
 Intelligent eye	To prevent the air from coming in direct contact with people. To save energy when nobody is in the room.
 Powerful	To cool down or heat up the room quickly.
 ON timer +  OFF	To automatically turn ON or OFF the system.
 Weekly timer	To automatically turn ON or OFF the system on a weekly basis.
Additional features	
Wireless LAN connection	To operate the unit using smart appliances.

4-3 Operation mode and temperature setpoint

When. Adjust the system operation mode, and set the temperature when you want to:

- Heat up or cool down a room
- Blow air in a room without heating or cooling
- Decrease the humidity in a room

What. The system operates differently depending on the user selection.

Setting	Description
 Automatic	The system cools down or heats up a room to the temperature setpoint. It automatically switches between cooling and heating if necessary.
 Drying	The system decreases the humidity in a room without changing the temperature.
 Heating	The system heats up a room to the temperature setpoint.
 Cooling	The system cools down a room to the temperature setpoint.
 Fan	The system only controls the airflow (airflow rate and airflow direction). The system does NOT control the temperature.

Additional info:

- Outside temperature.** The system's cooling or heating effect decreases when the outside temperature is too high or too low.
- Defrost operation.** During heating operation, frost might occur on the outdoor unit and decrease the heating capacity. In that case, the system automatically switches to defrosting operation to remove the frost. During defrosting operation, hot air is NOT blown from the indoor unit.
- Humidity sensor.** Control the humidity by decreasing the humidity during cooling process.

4-3-1 To start/stop operation and to set the temperature





 : Unit is operating.

 : Operation mode = Automatic

 : Operation mode = Drying

 : Operation mode = Cooling

 : Operation mode = Heating

 : Operation mode = Fan only

 : Shows the set temperature.



- Press  one or more times to select the operation mode.

Result: The mode will be set as follows:



- Press  to **start** operation.

Result:  and the selected mode are displayed on the LCD.

- Press  or  one or more times to lower or raise the temperature.

Cooling operation	Heating operation	Automatic operation	Drying or Fan only operation
18~32°C	10~30°C	18~30°C	—

Note: When using **drying** or **fan only** mode, you cannot adjust the temperature.

4. Press to **stop** operation.

Result: **ON** disappears from the LCD. The operation lamp goes off.

4-3-2 Airflow rate

1. Press to choose:

	5 airflow rate levels, from “” to “”
	Automatic operation
	Indoor unit quiet operation. When the airflow is set to “”, the noise from the unit will be reduced.

Note: When using **drying** operation mode, you CANNOT adjust the airflow rate setting.

To adjust the airflow rate

1. Press to change the airflow setting as follows:



4-3-3 Airflow direction

When. Adjust the airflow direction as desired.

What. The system directs the airflow differently, depending on the user selection (swinging or fixed position). It does so by moving horizontal blades (flaps) or vertical blades (louvres).

Setting	Airflow direction
Vertical automatic swing	Moves up and down.
Horizontal automatic swing	Moves from side to side.
3-D airflow direction	Moves simultaneously up and down and from side to side
[-]	Stays in a fixed position.

CAUTION

- ALWAYS use a remote controller to adjust the position of the flaps and louvres. When the flaps and louvres are swinging and you move them forcibly by hand, the mechanism will break.
- Be careful when adjusting the flaps and louvres. Inside the air outlet, a fan is rotating at high speed.

Note: The movable range of the flap varies according to the operation mode. The flap will stop at the upper position when the airflow rate is changed to low during the up and down swing setting.

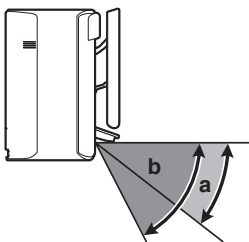

- a Flap range in cooling or drying operation
- b Flap range in heating or fan only operation

To adjust vertical airflow direction

1. Press .

Result: appears on the LCD. The flaps (horizontal blades) will begin to swing.

2. To use fixed position, press when the flaps reach the desired position.

Result: disappears from the LCD. The flaps will stop moving.

To adjust horizontal airflow direction

1. Press .

Result: appears on the LCD. The louvres (vertical blades) will begin to swing.

2. To use fixed position, press when the louvres reach the desired position.

Result: disappears from the LCD. The flaps will stop moving.

To use 3-D airflow direction

1. Press and .

Result: and appear on the LCD. The flaps (horizontal blades) and louvres (vertical blades) will begin to swing.

2. To use fixed position, press and when the flaps and louvres reach the desired position.

Result: and disappear from the LCD. The flaps and the louvres will stop moving.

4-3-4 Comfort airflow and Intelligent eye operation

You can use Comfort and Intelligent eye operation separately, or combine them.

Comfort airflow operation

The unit will automatically change the direction of the airflow to heat up or cool down the room more effectively. Direct airflow from the unit will be less noticeable.

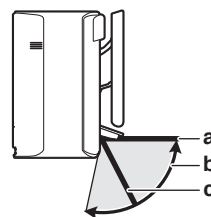

- a Flap position in cooling and dry operation
- b Flap range in heating operation (vertical airflow ON)
- c Flap position in heating operation (vertical airflow OFF)

In cooling and drying

The airflow direction will change to spread the air along the ceiling.

Comfort airflow ON	Comfort airflow OFF

In heating

The airflow direction will change to spread the air along the floor. The unit detects the room and floor temperature and automatically selects 1 of the 3 airflow directions.

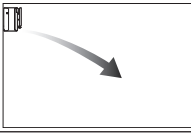
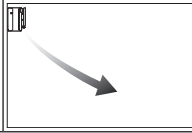
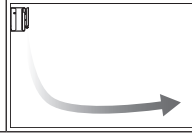
Warming up	Downward direction	Vertical airflow direction
		

Vertical airflow direction sends air directly downward, so if there is a curtain rail or other object below the air conditioner that obstructs the flow of air, in some cases it may not be sufficiently effective.

INFORMATION

If you want to deactivate the Vertical airflow function (e.g. in case there is furniture or another object under the unit), refer to "To turn ON/OFF Vertical airflow function" on page 9. If the Vertical airflow function is deactivated, the airflow will be set to downward direction.

INFORMATION



Powerful and Comfort airflow operation CANNOT be used at the same time. The last selected function takes priority.

If the Vertical automatic swing is selected, Comfort airflow operation will be cancelled.

To turn ON/OFF Vertical airflow function

1. Press  for at least 2 seconds.

Result: The menu 1 appears on the display.

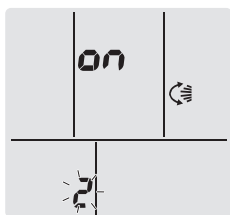

2. Press  or  to change the menu screen.

Result: The menu 2 appears on the display.



3. Press  to change the setting.

4. Press  or  to change the setting.

...is blinking	Vertical airflow function is...
	turned ON
	turned OFF

5. To confirm the selected setting press .

Note: The display automatically returns to the default screen after 60 seconds. To return to the default screen sooner, press  twice.

Intelligent eye operation

The system detects movement in the room and automatically adjusts the airflow direction and temperature in order to avoid direct contact with people. If no movement is detected for 20 minutes, the system switches to energy saving operation:

Operation	Energy saving operation
Heating	Temperature is lowered by 2°C.
Cooling and drying	If the temperature in the room is: <ul style="list-style-type: none"> • ≤30°C, the temperature is raised by 2°C • >30°C, the temperature is raised by 1°C
Fan only	Decreases airflow rate.

About Intelligent eye sensor

NOTICE

- Do NOT hit or push the Intelligent eye sensor. Doing so may lead to malfunction.
- Do NOT place large objects near the Intelligent eye sensor.

- **Detection range.** Up to 9 m.

If the installation height is 180cm or less, the distance at which detection is possible will become shorter.



- **Detection sensitivity.** Changes according to location, the number of persons in the room, temperature range, etc.
- **Detection mistakes.** Sensor may mistakenly detect pets, sunlight, moving curtains, etc.

To start/stop Comfort and Intelligent eye operation

1. Press  one or more times.

Result: The setting will change as follows:

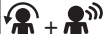

Display	Operation
	Comfort airflow
	Intelligent eye
	Comfort airflow and Intelligent eye
—	Both deactivated

Note: If there are people close to the front of the indoor unit or there are too many people, use both operations at the same time.

2. To stop operation, press  until both symbols disappear from the LCD.

4-3-5 Powerful operation

This operation quickly maximises the cooling/heating effect in any operation mode. You can get the maximum capacity.

INFORMATION

Powerful operation CANNOT be used together with Econo, Comfort airflow, Intelligent eye and Outdoor unit quiet operation. The last selected function takes priority.

Powerful operation will NOT increase the capacity of the unit if it already operates at maximum capacity.

To start/stop Powerful operation

1. Press  to start.



Result:  is displayed on the LCD. Powerful operation runs for 20 minutes; after that, operation returns to the previously set mode.

Mode	Airflow rate
Cooling/Heating/Automatic	<ul style="list-style-type: none"> • To maximise the cooling/heating effect, the capacity of outdoor unit is increased. • The airflow rate is fixed to the maximum setting and CANNOT be changed. The temperature can be set only in Automatic mode.
Drying	<ul style="list-style-type: none"> • The temperature setting is lowered by 2.5°C. • The airflow rate is slightly increased.
Fan only	The airflow rate is fixed to the maximum setting.

2. Press  to stop.

Result:  disappears from the LCD.

Note: Powerful operation can only be set when the unit is running.

Press  to cancel this mode;  disappears from the LCD.

4-3-6 Econo and Outdoor unit quiet operation

Econo operation

This is a function which enables efficient operation by limiting the maximum power consumption value. This function is useful for cases in which attention should be paid to ensure a circuit breaker will not trip when the product runs alongside other appliances.

INFORMATION

- Powerful and Econo operation CANNOT be used at the same time. The last selected function takes priority.
- Econo operation reduces power consumption of the outdoor unit by limiting the rotation speed of the compressor. If power consumption is already low, Econo operation will NOT further reduce power consumption.

Outdoor unit quiet operation

Use Outdoor unit quiet operation when you want to decrease the noise level of the outdoor unit. **Example:** At night.

INFORMATION



- Powerful and Outdoor unit quiet operation CANNOT be used at the same time. The last selected function takes priority.
- This function is only available in Automatic, Cooling, and Heating operation.
- Outdoor unit quiet operation limits the rotation speed of the compressor. If the rotation speed of compressor is already low, Outdoor unit quiet operation will NOT further reduce the compressor rotation speed.

To start/stop Econo and Outdoor unit quiet operation

1. Press  one or more times.



Result: The setting will change as follows.

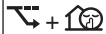

Display	Operation
	Econo
	Outdoor unit quiet
	Econo and Outdoor unit quiet
—	Both deactivated

2. To stop operation, press  until both symbols disappear from the LCD.

Note: Econo operation can be only set when the unit is running.

Pressing  cancels the setting and  disappears from the LCD.

Note:  remains on the LCD, even if you turn off the unit using the remote controller or indoor unit ON/OFF switch.





4-4 Flash streamer air cleaning operation

Streamer generates a high-speed electron stream with a high oxidizing power, reducing bad odours and viruses. Together with the titanium apatite deodorising filter and the air filters, this function cleans the air in the room.

INFORMATION

- The high-speed electrons are generated and go away inside the unit to ensure safe operation.
- The streamer discharge may generate a fizzing sound.
- If the airflow becomes weak, the Streamer discharge may stop temporarily to prevent ozone smell.
- If the airflow rate is set to indoor unit quiet, the Streamer will not function (for 25 / 35 class).

4-4-1 To start/stop Flash streamer operation

1. Press .
Result:  is displayed on the LCD and the air in the room is cleaned.
2. To stop operation, press .
Result:  disappears from the LCD and operation stops.

4-5 OFF/ON timer operation

Timer functions are useful for automatically switching the air conditioner on/off at night or in the morning. You can also use OFF timer and ON timer in combination.

INFORMATION



Programme the timer again in case of:

- A circuit breaker has turned the unit off.
- A power failure.
- After replacing batteries in the remote controller.



INFORMATION

The clock MUST be set correctly before using any timer functions. Refer to "3-3-1 To set the clock" on page 5.

4-5-1 To start/stop OFF timer operation

1. Press  to start.
Result:  is displayed on the LCD, the timer lamp lights up, and OFF blinks. ☉ and the day of the week disappear from the LCD.





2. Press  or  to change the time setting.
3. Press  again.

Result: OFF and the set time are displayed on the LCD.

Result: The timer lamp lights up.

INFORMATION

Each time  or  is pressed, the time setting advances by 10 minutes. Holding the button down will change the setting rapidly.



4. To stop operation, press .

Result:  and OFF disappear from the LCD and the timer lamp goes off. ☉ and the day of the week are displayed on the LCD.



INFORMATION

When you set the ON/OFF timer, the time setting is stored in the memory. The memory will be reset when the remote controller batteries are replaced.

4-5-2 To start/stop ON timer operation

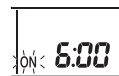

1. Press  to start.
Result:  is displayed on the LCD, the timer lamp lights up, and ON blinks. ☉ and the day of the week disappear from the LCD.



2. Press  or  to change the time setting.
3. Press  again.

Result: ON and the set time are displayed on the LCD. The timer lamp lights up.

INFORMATION

Each time  or  is pressed, the time setting advances by 10 minutes. Holding the button down will change the setting rapidly.

4. To stop operation, press .

Result:  and ON disappear from the LCD and the timer lamp goes off. ☉ and the day of the week are displayed on the LCD.

4-5-3 To combine OFF timer and ON timer

1. To set the timers, refer to "4-5-1 To start/stop OFF timer operation" on page 11 and "4-5-2 To start/stop ON timer operation" on page 11.

Result: OFF and ON are displayed on the LCD.

Example:

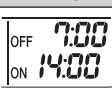
Display	Current time	Set while...	Operation...
	6:00	the unit is operating.	stops at 7:00 and starts at 14:00.
		the unit is NOT operating.	starts at 14:00.

Note: If the timer setting is active, the current time is NOT displayed on the LCD.

4-6 Weekly timer operation

With this operation, you can save up to 4 timer settings for each day of the week.

Example: Create a different setting from Monday to Friday and a different setting for weekends.

Day of the week	Setting example
Monday • Make up to 4 settings.	
Tuesday~Friday • Use the copy mode if the settings are the same as for Monday.	
Saturday • No timer setting	—
Sunday • Make up to 4 settings.	

- **ON-ON-ON-ON setting.** Enables scheduling the operation mode and set temperature.
- **OFF-OFF-OFF-OFF setting.** Only the turn off time can be set for each day.

Note: Be sure to aim the remote controller at the indoor unit and check for a receiving tone when setting the Weekly timer operation. See “2-2-3 To operate the remote controller” on page 4.

INFORMATION

The clock MUST be set correctly before using any timer functions. Refer to “3-3-1 To set the clock” on page 5.

INFORMATION

- Weekly timer and ON/OFF timer operation CANNOT be used at the same time. The ON/OFF timer operation takes priority. Weekly timer will be in standby, disappears from the LCD. When the ON/OFF timer is completed, the Weekly timer becomes active.
- The day of the week, ON/OFF timer mode, time and temperature (only for ON timer) can be set with the Weekly timer. Other settings are based on previous ON timer setting.

4-6-1 To set Weekly timer operation

1. Press .

Result: The day of the week and the reservation number of the current day are displayed.



2. Press or to select the day of the week and the reservation number.

3. Press .

Result: The day of the week is set. and ON blink.

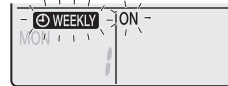

4. Press or to select the mode.

Result: The setting will change as follows:



Display	Feature
ON	ON timer
OFF	OFF timer
Blank	Deletes reservation

5. Press .

Result: The ON/OFF timer mode is set. and the time blink.

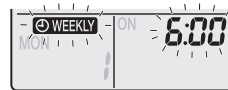

Note: Press to return to the previous screen. If blank is selected, continue to step 9.

6. Press or to select the time. The time can be set between 0:00~23:50 in 10 minute intervals.

7. Press .

Result: The time is set and and the temperature blink.



Note: Press to return to the previous screen. If OFF timer is selected, continue to step 9.

8. Press  or  to select the desired temperature.

Note: The set temperature for the weekly timer is displayed only when setting the weekly timer mode.

INFORMATION

The temperature can be set between 18~30°C.

9. Press .

Result: Temperature and time are set in ON timer. Time is set in OFF timer. Timer lamp lights orange.

Result: New reservation screen will appear.

10. Repeat the previous procedure to set another reservation or press  to complete the setting.

11. Press  to complete the setting.



Result:  is displayed on the LCD.

Note: A reservation can be copied with same setting to another day. Refer to “4-6-2 To copy reservations” on page 13.

4-6-2 To copy reservations

A reservation can be copied to another day. The complete reservation of the selected day of the week will be copied.



1. Press .

2. Press  or  to select the day of the week to be copied.

3. Press .

Result: The reservation of the selected day of the week will be copied.



4. Press  or  to select the destination day.

5. Press .

Result: The whole reservation is copied to the selected day and the timer lamp lights orange.

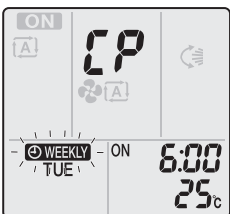

Note: To copy to another day, repeat the procedure.

6. Press  to complete the setting.

Result:  is displayed on the LCD.

Note: To change the reservation setting after copying, refer to “4-6-1 To set Weekly timer operation” on page 12.



4-6-3 To confirm reservations

You can confirm if all reservations are set to your needs.

1. Press .

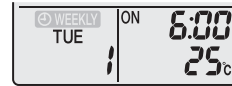
Result: The day of the week and the reservation number of the current day are displayed.





2. Press  or  to select the day of the week and reservation number to be confirmed and check the reservation details.

Note: To change the reservation setting, refer to “4-6-1 To set Weekly timer operation” on page 12.

3. Press  to exit the confirmation mode.

4-6-4 To deactivate and reactivate Weekly timer operation

1. To deactivate the Weekly timer, press  while  is displayed on the LCD.

Result:  disappears from the LCD and the timer lamp goes off.

2. To reactivate the Weekly timer, press  again.

Result: The last set reservation mode will be used.



4-6-5 To delete reservations

To delete individual reservations

Use this function if you want to delete a single reservation setting.

1. Press .

Result: The day of the week and the reservation number are displayed.

2. Press  or  to select the day of the week to be deleted.

3. Press .

Result: , ON, and OFF blink.

4. Press  or  and select “blank”.

Result: The setting will change as follows:



5. Press .

Result: The selected reservation is deleted.

6. Press  to exit.

Result: Remaining reservations will be active.

To delete a reservation for each day of the week

Use this function if you want to delete all reservation settings for one day of the week. This can be used in confirmation or setting mode.

1. Press  or  to select the day of the week to be deleted.

2. Hold  for about 5 seconds.

Result: All reservations for the selected day will be deleted.

To delete all reservations

Use this function if you want to delete all reservations for all days of the week in one go. This procedure CANNOT be used in the setting mode.

1. Hold **Weekly** for about 5 seconds while in the default display.

Result: All reservations will be deleted.

4-7 Wireless LAN connection

If using a remote control PC-board or an interface adaptor for DIII-NET, it is necessary to switch the wireless LAN connection adapter to OFF.

The user is responsible for providing:

- Smartphone, tablet or another smart device with one of the following operating systems:
 - Android 4.0.3 or later
 - iOS 7.1.2 or later
- Internet line and communication device, such as a modem, router, etc.
- Wireless LAN access point
- Installed free **Daikin Mobile Controller** application

Note: If needed, the SSID number and the KEY are located on the unit or can be found in the accessory bag.

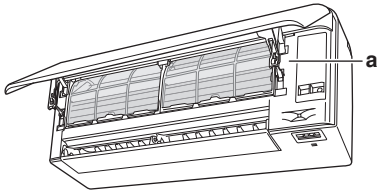

a Label with SSID number and password

4-7-1 Precautions when using the wireless adapter

Do NOT use near:

- **Medical equipment.** E.g. persons using cardiac pacemakers or defibrillators. This product may cause electromagnetic interference.
- **Auto-control equipment.** E.g. automatic doors or fire alarm equipment. This product may cause faulty behaviour of the equipment.
- **Microwave oven.** It may affect wireless LAN communications.

4-7-2 To install the Daikin Mobile Controller application

1. Open:
 - Google Play for appliances using Android.
 - App Store for appliances using iOS.
2. Search for Daikin Mobile Controller.
3. Follow the directions on the screen to install.

4-7-3 To set the wireless connection

There are 2 options to connect the wireless adapter with your smart device.

- **Connect the wireless adapter to your home network.**
The wireless adapter will communicate with your smart device in your home network using a modem, router or a similar device.
- **Connect the wireless adapter to your smart device directly.**

For more information and FAQ refer to:

<http://www.daikinthai.com/dmobile/index.html>

1. Stop the operation before setting the wireless connection.

To confirm the wireless adapter connection status

1. Hold **WPS** for at least 5 seconds.

Result: The confirmation display (menu **!**) appears.

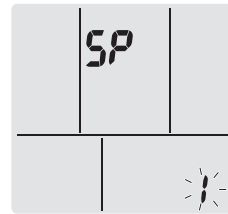

2. Press **WPS** to confirm the selection.

Result: **!** is blinking.

3. Check the indoor unit LED.

...lamp is blinking.	Status
Timer	Communication is OK
Operation and timer	Communication is OFF

4. Press **Cancel** to exit the menu.

Result: The display will return to the default screen.

To connect the wireless adapter to your home network

The wireless adapter can be connected to your home network using the:

- **WPS** button on the router (if present).
- **SSID** and **KEY** number on the unit.

To connect using the WPS button

1. Hold **WPS** for at least 5 seconds in the default screen.
Result: The confirmation display (menu **!**) appears.
2. Press repeatedly **Temp** or **Temp** until the WPS setting display (menu **?**) appears.

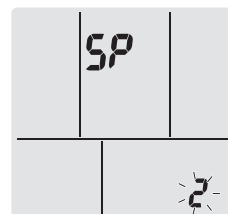

3. Press  to confirm the selection.

Result: 2 is blinking.

4. Press the WPS button on your communication device (e.g.router) within approximately 1 minute. Refer to the manual of your communication device.

Result: The timer LED is blinking.

5. Press  to exit the menu.

Result: The display will return to the default screen.

Note: If the blinking of the timer lamp does not slow down and the timer lamp goes out, repeat steps 1 through 5.

If connection is still impossible, use the procedures in “To connect the wireless adapter to your device directly” to perform setting.

To connect the wireless adapter to your device directly

1. Hold  for at least 5 seconds in the default screen.

Result: The confirmation display (menu 1) appears.

2. Press repeatedly  or  until the AP setting display (menu 3) appears.

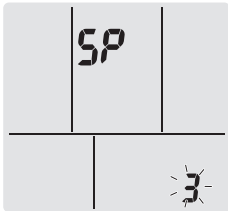

3. Press  to confirm the selection.

Result: 3 is blinking.

4. Connect with your smart device to the access point in the same way as to a standard wireless network.

- Select the SSID (DaikinAP*****) printed on the unit or in the accessory set, and enter the password.

Result: The operation and timer LEDs are blinking.

5. Press  to exit the menu.

Result: The display will return to the default screen.

6. Open the application and tap “Configure the wireless connection”, then connect to the home network following the instructions on the screen.

7. Connect your smartphone to the home network.

To reset the connection setting to the factory default

Reset the connection setting to the factory default in case you want to:

- switch between the WPS and the AP connection option,
- disconnect the Wi-Fi adapter and the communication device (e.g.router) or smart device,
- repeat the setting if the connection was unsuccessful.

1. Hold  for at least 5 seconds in the default screen.

Result: The confirmation display (menu 1) appears.

2. Press repeatedly  or  until the A display (menu 2) appears.

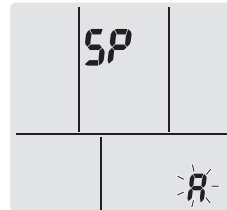

3. Hold  for at least 2 seconds to confirm the selection.

Result: 2 is blinking. The setting is reset to the factory default.

4. Press  to exit the menu.

Result: The display will return to the default screen.

To turn off the wireless connection

You can turn off the wireless connection using:

- the remote controller,
- the wireless adapter ON/OFF button on the unit.

To use the wireless adapter ON/OFF switch

1. Press the wireless adapter ON/OFF switch.



Result: The wireless adapter communication is OFF.

Note: Press the ON/OFF switch again to turn on the wireless adapter.

To use the remote controller

1. Hold  for at least 5 seconds in the default screen.

Result: The confirmation display (menu 1) appears.

2. Press repeatedly  or  until the OFF menu appears.

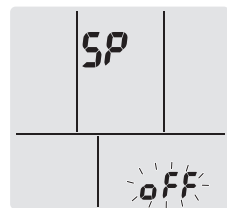

3. Hold  for at least 2 seconds to confirm the selection.

Result: OFF is blinking. Communication is OFF. The operation and timer LEDs are blinking.

4. Press  to exit the menu.

Result: The display will return to the default screen.

5. Energy saving and optimum operation



INFORMATION

- Even if the unit is turned OFF, it consumes electricity.
- When the power turns back on after a power break, the previously selected mode will be resumed.



CAUTION

NEVER expose little children, plants or animals directly to the airflow.



WARNING

Do NOT place objects below the indoor and/or outdoor unit that may get wet. Otherwise condensation on the unit or refrigerant pipes, air filter dirt or drain blockage may cause dripping, and objects under the unit may get dirty or damaged.



NOTICE

Do NOT use the system for other purposes. In order to avoid any quality deterioration, do NOT use the unit for cooling precision instruments, food, plants, animals, or works of art.



WARNING

Do NOT place a flammable spray bottle near the air conditioner and do NOT use sprays. Doing so may result in a fire.

Observe the following precautions to ensure the system operates properly.

- Prevent direct sunlight from entering a room during cooling operation by using curtains or blinds.
- Ventilate often. Extended use requires special attention to ventilation.
- Keep doors and windows closed. If the doors and windows remain open, air will flow out of your room causing a decrease in the cooling or heating effect.
- Be careful NOT to cool or heat too much. To save energy, keep the temperature setting at a moderate level.
- NEVER place objects near the air inlet or the air outlet of the unit. Doing so may cause a reduced heating/cooling effect or stop operation.
- Turn off the main power supply switch to the unit when the unit is NOT used for longer periods of time. If the main power supply switch is on, the unit consumes electricity. Before restarting the unit, turn on the main power supply switch 6 hours before operation to ensure smooth running.
- Condensation may form if the humidity is above 80% or if the drain outlet gets blocked.

- Adjust the room temperature properly for a comfortable environment. Avoid excessive heating or cooling. Notice that it may take some time for the room temperature to reach the set temperature. Consider using the timer setting options.
- Adjust the airflow direction to avoid cool air from gathering on the floor or warm air against the ceiling. (Up during cooling or dry operation to the ceiling and down during heating operation.)
- Avoid direct airflow to room inhabitants.
- Operate the system within the recommended temperature range (26~28°C for cooling and 20~24°C for heating) to save energy.

6. Maintenance and service

6-1 Overview: Maintenance and service

The installer has to perform yearly maintenance.



WARNING

- The refrigerant inside the unit is mildly flammable, but normally does NOT leak. If the refrigerant leaks in the room and comes in contact with fire from a burner, a heater, or a cooker, this may result in fire, or the formation of a harmful gas.
- Turn off any combustible heating devices, ventilate the room, and contact the dealer where you purchased the unit.
- Do NOT use the unit until a service person confirms that the part from which the refrigerant leaked has been repaired.
- Do NOT pierce or burn refrigerant cycle parts.
- Do NOT use cleaning materials or means to accelerate the defrosting process other than those recommended by the manufacturer.
- Be aware that the refrigerant inside the system is odourless.
- The appliance shall be stored in a room without continuously operating ignition sources (example: open flames, an operating gas appliance or an operating electric heater).

— **!** NOTICE —

Maintenance **MUST** be done by an authorized installer or service agent.

We recommend performing maintenance at least once a year. However, applicable legislation might require shorter maintenance intervals.

— **!** WARNING —

To prevent electric shock or fire:

- Do NOT rinse the unit.
- Do NOT operate the unit with wet hands.
- Do NOT place any objects containing water on the unit.

— **!** CAUTION —

- After a long use, check the unit stand and fitting for damage. If damaged, the unit may fall and result in injury.
- Do NOT touch the heat exchanger fins. These fins are sharp and could result in cutting injuries.

— **!** WARNING —

Be careful with ladders when working in high places.

6-2 To clean the indoor unit and remote controller

— **!** NOTICE —

- Do NOT use petrol, benzine, thinner polishing powder or liquid insecticide. **Possible consequence:** Discoloration and deformation.
- Do NOT use water or air of 40°C or higher. **Possible consequence:** Discoloration and deformation.
- Do NOT use polishing compounds.
- Do NOT use a scrubbing brush. **Possible consequence:** The surface finishing peels off.

— **!** DANGER: RISK OF ELECTROCUTION —

Before cleaning, be sure to stop the operation, turn the circuit breaker off or pull out the supply cord. Otherwise, an electric shock and injury may result.

1. Clean with a soft cloth. If it is difficult to remove stains, use water or a neutral detergent.

6-3 To clean the front panel

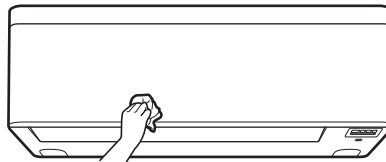

1. Clean the front panel with a soft cloth. If it is difficult to remove stains, use water or a neutral detergent.

6-4 To open the front panel

Open the front panel using the remote controller.

1. Stop operation.
2. Hold ⊕ on the remote controller for at least 2 seconds. **Result:** The front panel will open.

Note: Press and hold ⊕ again for at least 2 seconds to close the front panel.

3. Turn the power supply off.
4. Pull down both locks on the back of the front panel.
5. Open the front panel and engage the support with the fixing tab.

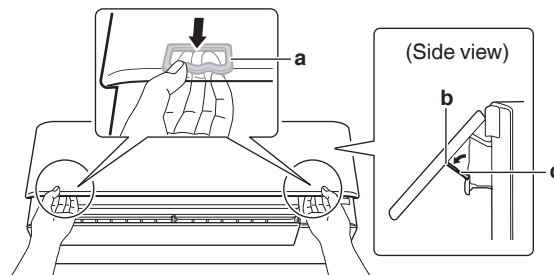

- a Lock (1 on each side)
- b Fixing tab
- c Support

— **i** INFORMATION —

If you **CANNOT** find the remote controller or use another optional controller, put your fingers on both sides of the front panel and pull it up slowly.

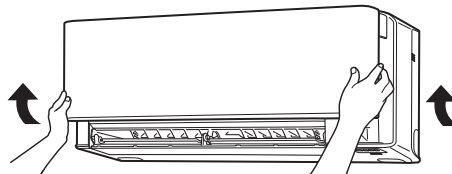

6-5 About the air filters

Operating the unit with dirty filters means that the filter:

- **CANNOT** deodorise the air,
- **CANNOT** clean the air,
- poor heating/cooling,
- causes odour.

6-6 To clean the air filters

1. Hold the tab at the centre of each air filter and pull up a little.
2. Pull out the air filters.

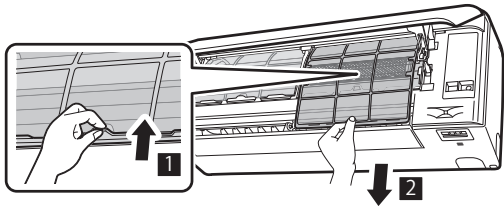

3. Remove the titanium apatite deodorising filter from the tabs.

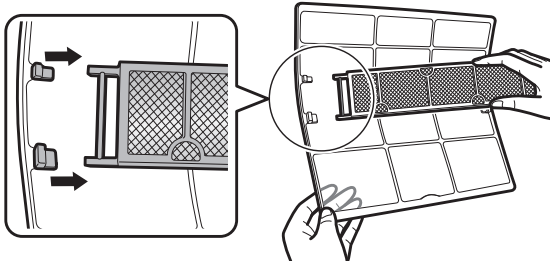

4. Wash the air filters with water or clean them with a vacuum cleaner.

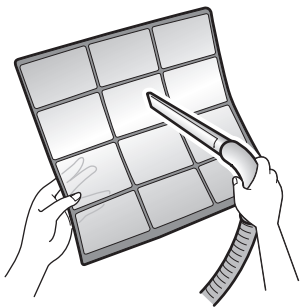

5. Soak in lukewarm water for about 10 to 15 minutes.

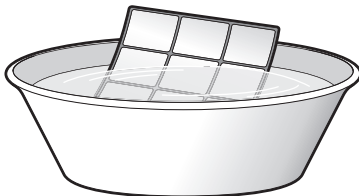

i INFORMATION

- If the dust does NOT come off easily, wash them with a neutral detergent diluted in lukewarm water. Dry the air filters in the shade.
- It is recommended to clean the air filters every 2 weeks.

6-7 To clean the titanium apatite deodorising filter

i INFORMATION

Clean the filter with water every 6 months.

1. Remove the dust from the filter with a vacuum cleaner.

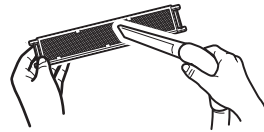

i INFORMATION

- Replace the filter every 3 years.
- Dispose of the old filter as non-flammable waste.
- To order a titanium apatite deodorising filter, contact the dealer where you bought the air conditioner.

Item	Titanium apatite deodorising filter (1 set)
Part No.	KAF087A41(with frame)

6-8 To close the front panel

1. Set the filters as they were.
2. Lift the front panel slightly and remove the support from the fixing tab.
3. While pushing the support upward, push the front panel closed until it stops.

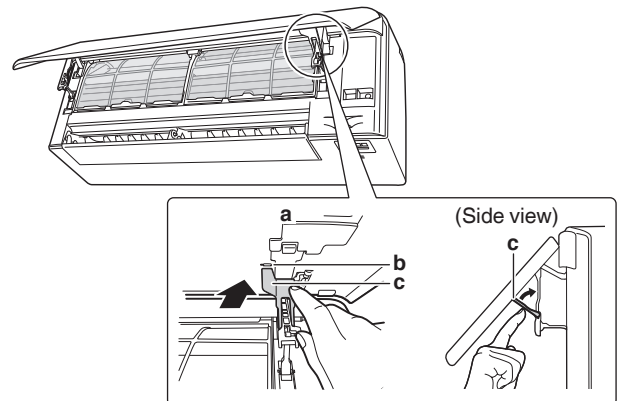

- a Backside of the front panel
- b Fixing tab
- c Support

4. Gently push the front panel until a click is heard.

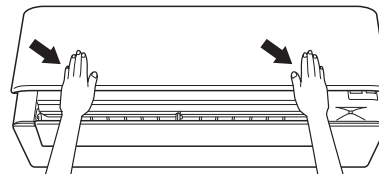

6-9 To remove the front panel

i INFORMATION

Remove the front panel only in case it MUST be replaced.

1. Open the front panel. See "6-4 To open the front panel" on page 17.
2. Open the panel locks located on the back side of the panel (1 on each side).

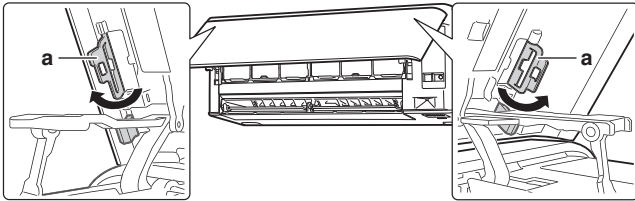

a Panel lock

3. Push the right arm lightly to the right to disconnect the shaft from the shaft slot on the right side.

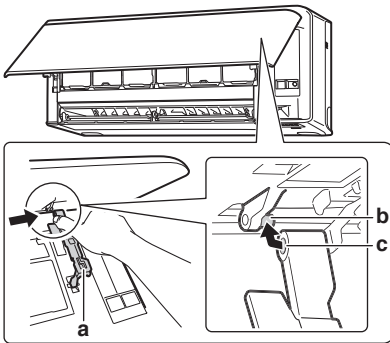

a Arm
b Shaft
c Shaft slot

4. Disconnect the front panel shaft from the shaft slot on the left side.

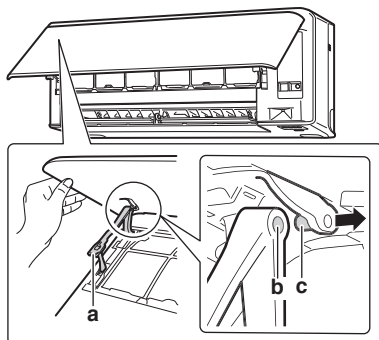

a Arm
b Shaft slot
c Shaft

5. Remove the front panel.
6. To re-install the front panel perform the steps in the opposite order.

6-10 Take following items into account before a long idle period

Operate the unit several hours in **fan only** mode to dry the inside of the unit.

1. Press **Mode** and select operation.
 2. Press and start operation.
 3. After operation stops, turn the circuit breaker off.
 4. Clean the air filters and replace them in their original position.
 5. Remove the batteries from the remote controller.
- When starting to use the air conditioner again, make sure that the drain hose outlet is not blocked, then turn on the circuit breaker. An operational check of each component will be carried out automatically. (Also, put the batteries into the remote controller.)

i INFORMATION

It is recommended to have periodical maintenance performed by a specialist. For specialist maintenance, contact your dealer. Maintenance costs shall be borne by the user.

In certain operating conditions the inside of the unit may get dirty after several seasons of use. This results in poor performance.

7. Troubleshooting

If one of the following malfunctions occur, take the measures shown below and contact your dealer.

! WARNING

Stop operation and shut off the power if anything unusual occurs (burning smells etc.).



Leaving the unit running under such circumstances may cause breakage, electric shock or fire. Contact your dealer.

The system **MUST** be repaired by a qualified service person:

Malfunction	Measure
If a safety device such as a fuse, a circuit breaker or an earth leakage circuit breaker frequently actuates or the ON/OFF switch does NOT properly work.	Turn OFF the main power switch.
Water is leaking from the indoor unit	If the drain hose is crushed or clogged, water from the indoor unit may be unable to drain and start leaking. Stop operation of the unit immediately and contact your dealer.
The operation switch does NOT work well.	Turn OFF the power supply.
If the remote controller display indicates the unit number, the operation lamp flashes and the malfunction code appears.	Notify your installer and report the malfunction code.

If the system does NOT properly operate except for the above mentioned cases and none of the above mentioned malfunctions is evident, investigate the system according to the following procedures.

Malfunction	Measure
If the system does NOT operate at all.	<ul style="list-style-type: none"> • Check if there is no power failure. Wait until power is restored. If a power failure occurs during operation, the system automatically restarts immediately after power is restored. • Check if the front panel is opened during operation. Stop operation and restart the indoor unit using the remote controller. • Check if no fuse has blown or circuit breaker is activated. Change the fuse or reset the circuit breaker if necessary. • Check the batteries of the remote controller. • Check the timer setting.
The system suddenly stops operating.	<ul style="list-style-type: none"> • Check if the air inlet or outlet of the outdoor or indoor unit is NOT blocked by obstacles. Remove any obstacles and make sure the air can flow freely. • The air conditioner may stop operating after sudden large voltage fluctuations to protect the system. It automatically resumes operation after about 3 minutes.
The flaps do NOT start to swing immediately.	The indoor unit is adjusting the position of the flaps. The flaps will start moving soon.
Operation does NOT start soon.	In case the ON/OFF button was pressed right after operation was stopped or if the mode was changed. Operation will start after 3 minutes to protect the system.
The system operates, but cooling or heating is insufficient.	<ul style="list-style-type: none"> • Check the airflow rate setting. Refer to "4-3-2 Airflow rate" on page 8. • Check the temperature setting. Refer to "4-3-1 To start/stop operation and to set the temperature" on page 7. • Check if the airflow direction setting is appropriate. Refer to "4-3-3 Airflow direction" on page 8. • Check if the air inlet or outlet of the outdoor or indoor unit is NOT blocked by obstacles. Remove any obstacles and make sure the air can flow freely. • Check if the air filters are clogged. Clean the air filters. See "6 Maintenance and service" on page 16. • Check for open doors or windows. Close doors and windows to prevent wind from coming in. • Check if the position setting is appropriate for the installed position of the unit. Refer to "3-6 To change indoor unit position setting" on page 6. • Check if the unit is operating without the front panel raised. Refer to "2-1 Indoor unit" on page 3. • Check if the unit operates in Econo or Outdoor unit quiet operation. Refer to "4-3-6 Econo and Outdoor unit quiet operation" on page 10. • Check if there is any furniture directly under or next to the indoor unit. Move the furniture.

Malfunction	Measure
The system operates, but heating is insufficient (air is NOT blown from the unit).	<ul style="list-style-type: none"> • To prevent the release of cold air, air does not come out directly after operation is started. Please wait 1 to 4 minutes. • If a flowing sound is heard, the outdoor unit may be in defrost operation. Wait for about 4 to 12 minutes.
The front panel does NOT open.	Check for the obstacles and try to open the front panel using the remote controller. Refer to "6-4 To open the front panel" on page 17.
The ON/OFF timer does NOT operate according to the settings.	<ul style="list-style-type: none"> • Check if the Weekly timer and ON/OFF timer are set to the same time. Change or deactivate the setting. Refer to "4-5 OFF/ON timer operation" on page 11 and "4-6 Weekly timer operation" on page 12. • Check if the clock and the day of the week are set correctly. Refer to "3-3 Clock" on page 5.
Heating operation CANNOT be selected.	Check if the remote controller's jumper J8 has NOT been cut. 
An abnormal function happens during operation.	The air conditioner may malfunction because of lightning or radio waves. Turn the circuit breaker OFF and back ON.
The unit does NOT receive signals from the remote controller.	<ul style="list-style-type: none"> • Check the batteries of the remote controller. Refer to "3-2 To insert the batteries" on page 5. • Make sure that the transmitter is NOT exposed to direct sunlight. • Check if there are any electronic starter type fluorescent lamps in the room. Contact your dealer.
The remote controller display is blank.	Replace the batteries of the remote controller.
An error code is displayed on the remote controller.	Consult your local dealer. Refer to "7-2 Solving problems based on error codes" on page 21 for a detailed list of error codes.
Other electric appliances start to operate.	If the remote controller signals operate other electric appliances, move the other appliances away, and contact your dealer.
Drops of water form on the front panel	Check if the unit is operating without the front panel raised. Refer to "2-1 Indoor unit" on page 3.
The LCD is blinking and the remote controller cannot be operated.	Battery power has run out. Replace both batteries at the same time with new size AAA.LR03 (alkaline) batteries. Leaving exhausted batteries in the remote controller can result in injury due to battery leakage, rupturing or heating, or lead to equipment failure. (Even when the LCD is blinking,  remains functional.)
Unable to use the remote controller after exchanging the batteries	Remove the batteries for approximately 1 minute, or remove the batteries and press any button for approximately 15 seconds. This may improve conditions.

Malfunction	Measure
The OPERATION lamp is off, but the unit is operating	Check if the display brightness setting is set to "OFF." Refer to "3-4 Brightness of the indoor unit display" on page 6.
The display lamps on the unit are dark	Check if the display brightness setting is set to "Dark." Refer to "3-4 Brightness of the indoor unit display" on page 6.
Vertical airflow direction is not possible	<ul style="list-style-type: none"> Check if the vertical airflow direction setting is set to "OFF." Refer to "To turn ON/OFF Vertical airflow function" on page 9. When the outdoor temperature or the temperature of the floor is low, vertical airflow direction may be inactive.
The ceiling and walls around the indoor unit are black and dirty	Due to the circulation pattern of the air and static electricity, the air conditioner is causing airborne dirt and dust to stick to walls and other surfaces. Depending on the wallpaper type, dirt may adhere more easily. A thorough cleaning of the area around the air conditioner is recommended.

If after checking all above items, it is impossible to fix the problem yourself, contact your installer and state the symptoms, the complete model name of the unit (with manufacturing number if possible) and the installation date (possibly listed on the warranty card).

7-1 Symptoms that are NOT system malfunctions

The following symptoms are NOT system malfunctions:

7-1-1 Symptom: A sound like water flowing is heard

- This sound is caused by the refrigerant flowing in the unit.
- This sound may be generated when water is flowing away from the unit during cooling or drying operation.

7-1-2 Symptom: A blowing sound is heard

This sound is generated when the direction of the refrigerant flow is changed (e.g. when switching from cooling to heating).

7-1-3 Symptom: A ticking sound is heard

This sound is generated when the unit slightly expands or contracts with changes in temperature.

7-1-4 Symptom: A whistling sound is heard

This sound is generated by the refrigerant flowing during defrost operation.

7-1-5 Symptom: A clicking sound during operation or idle time is heard

This sound is generated when the refrigerant control valves or electrical parts operate.

7-1-6 Symptom: A clapping sound is heard

This sound is generated when an external device sucks air out of the room (e.g. exhaust fan, extractor hood) while the doors and windows in the room are closed. Open the doors or windows, or turn off the device.

7-1-7 Hissing / Cracking sound

The sound of the Streamer discharge. It is not a malfunction.

7-1-8 A mechanical moving sound

- The sound made when the flaps, louvres, or front panel correct their positions at the beginning or end of operation, or while operation is stopped.
- It is the sound of the flaps, louvres, or front panel moving.

7-1-9 Symptom: White mist comes out of a unit (Indoor unit, outdoor unit)

■ In heating operation

When the system is changed over to heating operation after defrost operation. Moisture generated by defrost becomes steam and is exhausted.

■ In cooling or drying operation

Moisture in the air condenses into water on the cool surface of the outdoor unit piping and drips.

7-1-10 Symptom: The units can give off odours

- The indoor unit is blowing out room odours it has absorbed (the smell of walls or carpeting, furniture, clothes, and so on). If the air conditioner has been used for a long time, there is a chance that a dirty heat exchanger or fan are emitting an odour. We recommend you to have the indoor unit cleaned. Please consult your dealer. Do not spray the air conditioner unit with any deodorisers.
- Due to Streamer discharge, the air outlet may emit a slight odour as trace amounts of ozone are generated. However, the amount is negligible and is not harmful to your health.

7-1-11 Symptom: The outdoor fan rotates while the air conditioner is not in operation

- After operation has stopped.** The outdoor fan continues to rotate for another 30 seconds for system protection.
- While the air conditioner is not in operation.** When the outdoor temperature is very high, the outdoor fan starts to rotate for system protection.

7-2 Solving problems based on error codes

When a problem happens, an error code appears on the remote controller. It is important to understand the problem and to take measures before resetting an error code. This should be done by a licensed installer or by your local dealer.



This chapter gives you an overview of all error codes and the content of the error code as it appears on the remote controller.

For a more detailed troubleshooting guideline for each error, please see the service manual.

Fault diagnosis by remote controller

The remote controller can receive an error code from the indoor unit referring to the fault. It is important to understand the problem and take measures before resetting the error code. This should be done by a licensed installer or your local dealer.

To see the error code on the remote controller:

- Hold  for about 5 seconds.
Result:  blinks in the temperature display section.
- Press  repeatedly until a continuous beep is heard.
Result: The code is now displayed on the display.

INFORMATION

- A short beep and 2 consecutive beeps indicate noncorresponding codes.
- To cancel the code display, hold the  button for 5 seconds. The code will also disappear from the display if the button is NOT pressed within 1 minute.

System

Error code	Description
00	Normal
U0	Refrigerant shortage
U2	Overvoltage detection
U4	Signal transmission error (between indoor and outdoor unit)
UR	Indoor/outdoor unit combination fault

Indoor unit

Error code	Description
R1	Indoor unit PCB abnormality
R5	Freeze-up protection or high-pressure control
R6	Fan motor (DC motor) abnormality
RR	Streamer unit error
L4	Indoor heat exchanger thermistor abnormality
L7	Opening or closing front panel error
L9	Room temperature thermistor abnormality
LL	Humidity sensor error

Outdoor unit

Error code	Description
ER	4-way valve abnormality
E1	Outdoor unit PCB abnormality
E5	Overload activation (compressor overload)
E6	Compressor lock
E7	DC fan lock
E8	Input power overcurrent
F3	Discharge pipe temperature control
F6	High-pressure control (in cooling mode)
H0	Compressor system sensor abnormality
H6	Position sensor abnormality
H8	DC voltage / current sensor abnormality
H9	Outdoor temperature thermistor abnormality
J3	Discharge pipe thermistor abnormality
J6	Outdoor heat exchanger thermistor abnormality
L3	Electrical parts heat error
L4	Radiation fin temperature rise
L5	Inverter instantaneous overcurrent (DC)
P4	Radiation fin thermistor abnormality
F8	Compressor internal temperature error

7-3 Troubleshooting for wireless connection adapter

The following table provides a brief description of how to deal with some problems. If none of the following solutions fix the problem, go to <http://www.daikintha.com/dmobile/index.html> for more information and FAQ.

Problem	Measure
Connection to the WLAN adapter is not possible (none of the LEDs are blinking).	<ul style="list-style-type: none"> • Try operating the unit with the remote controller. • Check if the power is on. • Turn the unit off and back on again.
The WLAN adapter is NOT visible on the unit overview screen (Home screen) after configuration of the WLAN adapter (WPS option).	<ul style="list-style-type: none"> • Make sure the wireless LAN adapter is close enough to the communication device. • Check if communication is OK. See "To confirm the wireless adapter connection status" on page 14. • Make sure that the smart device is connected to the same wireless network as the WLAN adapter. • Try resetting to the factory default and repeat the setting. See "To reset the connection setting to the factory default" on page 15.
The WLAN adapter is NOT visible in the available Wi-Fi networks list on the smart device (Access point option).	<ul style="list-style-type: none"> • Try switching between access point and WPS setting to change the wireless channel. The wireless channel MUST be between 1~13. • Check if communication is OK. See "To confirm the wireless adapter connection status" on page 14. • Try to resetting to the factory default and repeat the setting. See "To reset the connection setting to the factory default" on page 15.

8. Disposal

— NOTICE —

Do NOT try to dismantle the system yourself: dismantling of the system, treatment of the refrigerant, oil and other parts MUST comply with applicable legislation.

Units MUST be treated at a specialised treatment facility for reuse, recycling and recovery.

DAIKIN INDUSTRIES, LTD.

Osaka Umeda Twin Towers South,
1-13-1, Umeda, Kita-ku, Osaka, 530-0001, Japan
<https://www.daikin.com>



The two-dimensional bar code is
a manufacturing code.

3P705032-1B M22N087A (2311) HT